

# S12-300 (12.8V300AH)

## TCSN Provides Safe and Efficient LFP Battery Solutions

S series adopt best value LiFePO4 cells, with the BMS system independently designed by TCSN. IP65 protection, support series and parallel use, is an ideal choice for outdoor, small energy storage, marine and other fields.

### FEATURES

- Safest Lithium Battery Technology
- Lighter Weight
- Eco-friendly
- Longer Life
- Multiple Safety Protection
- Intelligent Balancing Function
- 20 Years Designed Service Life



### PERFORMANCE



Cell	Square LFP 305Ah	Rated Charge Current	100A	Rated Discharge Current	100A
Terminal	M8	Max. Charge Current	200A	Max. Discharge Current	200A
IP Grade	IP65	Rated Charge Voltage	13.6~13.8V	Rated Discharge Cut-off Voltage	10.0V
Self Discharge	<=2%/Month	Maximum Operating Voltage	14.6V	Min. Operating Voltage	>9.6V
Cycle Life	6000times(80%DOD)	Balancing Voltage	>13.6V	Short Circuit Current	Approx.1000A

### SIZE

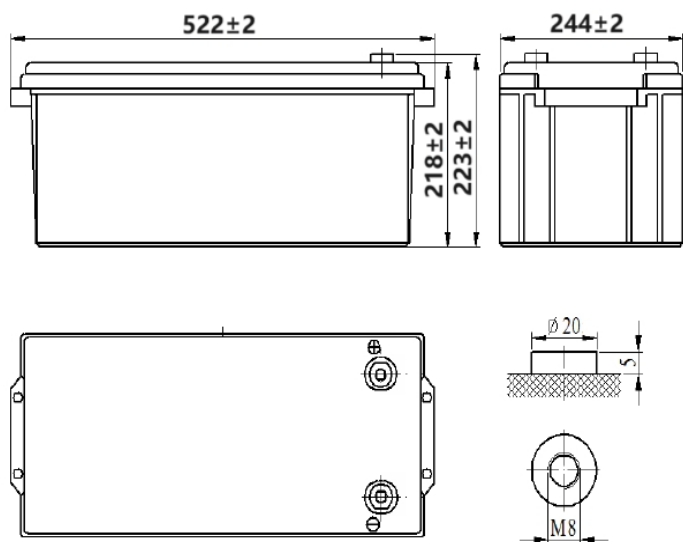

### PERFORMANCE PARAMETERS

Capacity	300Ah(0.5C@25 °C )
Nominal Voltage	12.8 V
Energy	3840Wh
Weight	27.0 kg
Dimensions	522*244*223 mm
Internal resistance	<10m
Storage Temp	-5°C to 35°C
Discharge Temp	-20°C to 55°C
Charge Temp	0°C to 45°C
Bluetooth function	Yes

### COMPLIANCE

Certifications	Cell	UN38.3
	Battery	UN38.3
Transport Appraisal	UN3480, CLASS 9	

## CHARACTERISTICS CURVE

Discharge Performance at 25°C

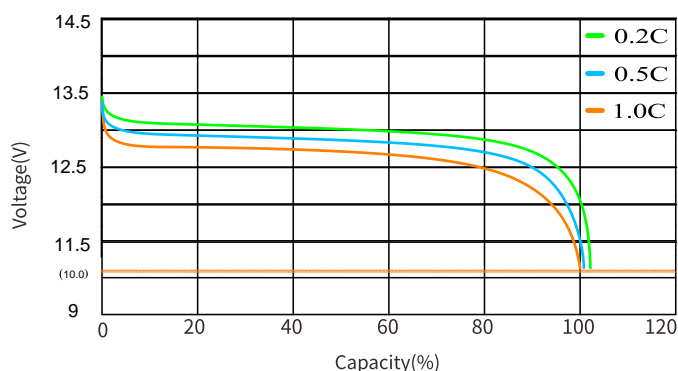

Charge and Discharge at 25°C, 0.5C

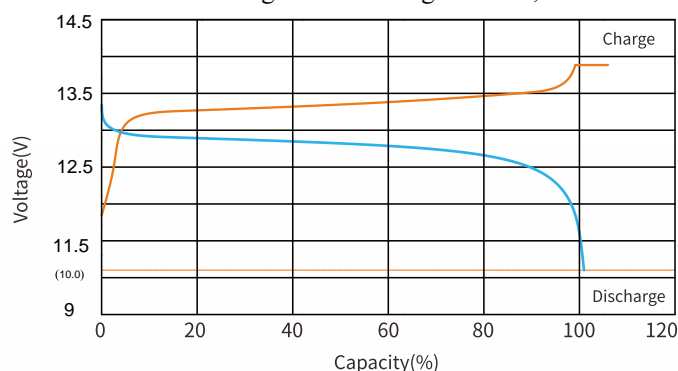

Temperature Effects on Capacity at 0.5C

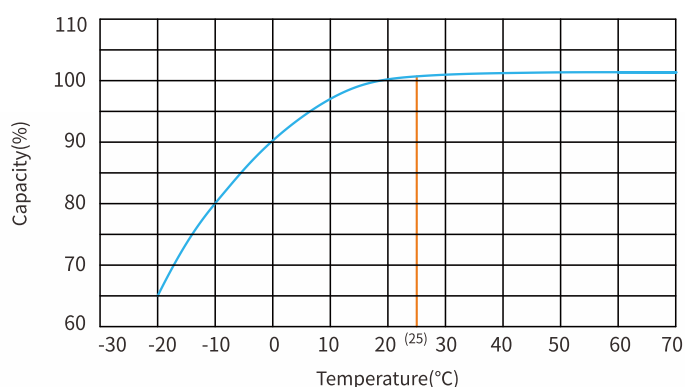

Cycle Life with DOD at 25°C  
1C Discharge and 1C Charge

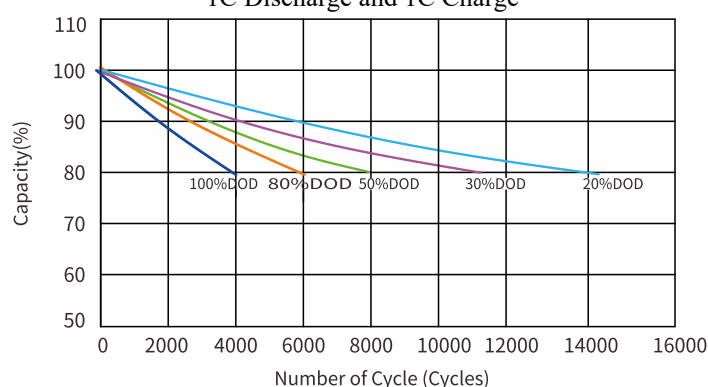

## CAUTIONS

1. Do NOT short circuit, crush or disassemble.
2. Do NOT heat or incinerate.
3. Do NOT immerse in any liquid.
4. Store at 50% capacity. Recharge every 3 months. The storage area should be clean, cool, dry and ventilated.
5. Disconnect charging source prior to connecting or disconnecting battery terminals.
6. Do not dispose of batteries in a fire as they can explode.
7. Do not open, alter, or mutilate batteries. Released electrolyte is harmful to skin and eyes. It may be toxic.
8. Do not mix different types and brands of lithium-ion batteries.
9. Do not dispose in trash, follow local regulations and manufacturer's instruction.
10. See installation instructions before connecting to the supply.
11. The battery cabinet receives power from more than one source. Disconnection of all DC sources is required to De-energize this unit before installing or servicing. Wait 5 minutes before opening the unit.
12. Do not install on or over combustible surfaces.
13. Refer to manual before servicing.
14. Do not touch bare terminals.
15. Country of origin is China