

SY series energy storage batteries





Introduce

TCSN SY series are designed for wall mounted solutions. For narrow space in Vehicles, Garage, moveable house, SY series provide, 25.6V and 51.2V storage system communicated with major inverter brands. Primatic cells adopted for all SY slim mounted line.

Features

 **Reliable and long-lasting**
 Cycle life: 8000 times (0.5C 80% DOD)
 Design life: 20 years

 **Safe and worry-free**
 Using LFP batteries ensures high safety, no fire, and no explosion.

 **Convenient stacking**
 Quick and stacked inverter assembly

 **Multiple protection**
 Various protective measures such as overvoltage, overcurrent, overheating and short circuit protection

Performance

Model	SY51.2-200-B
Performance	
Cell	Square LFP 200Ah
Terminal	Plug-in Terminal
IP Grade	IP21
Self Discharge	<=2%/Month
Cycle Life	8000times(0.5C 80%DOD)
Rec. Charge Current	75A
Max. Charge Current	150A
Rec. Charge Voltage	54.4~55.2V
Charge Cut-off Voltage	58.4V
Balancing Voltage	>54.4V
Rec. Discharge Current	75A
Max. Discharge Current	150A
Rec. Discharge Cut-off Voltage	44.8V
Min. Discharge Cut-off Voltage	>40V
Short Circuit Current	Approx.500A

Performance parameters	
Capacity	200 Ah(0.5C@25°C)
Nominal Voltage	51.2 V
Energy	10240 Wh
Weight	94 kg
Dimensions	600*200*650mm
Communication interface	RS485/CAN
LCD Panel	Push-button screen
Storage Temp	-5°C to 35°C
Discharge Temp	-20°C to 55°C
Charge Temp	0°C to 45°C

Size

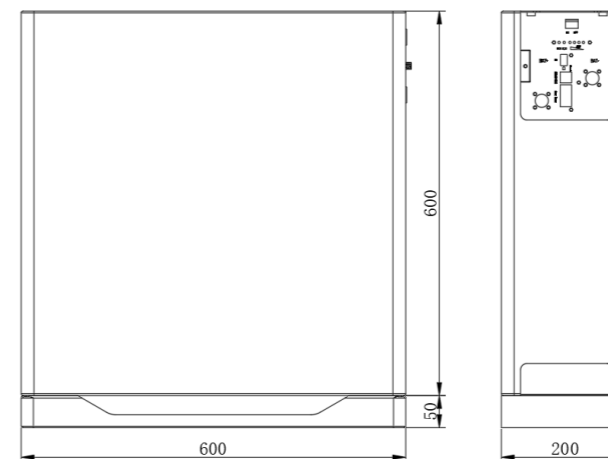

Compliance

Certifications	Cell UN38.3
	Battery UN38.3
Transport Appraisal	UN3480,CLASS 9

System Management Diagram

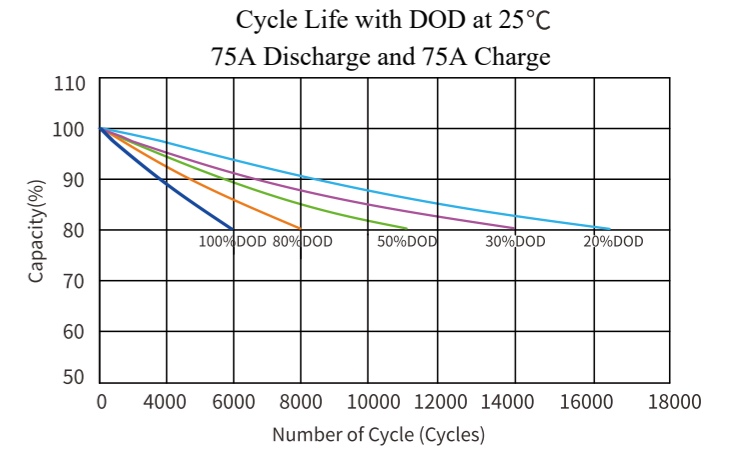
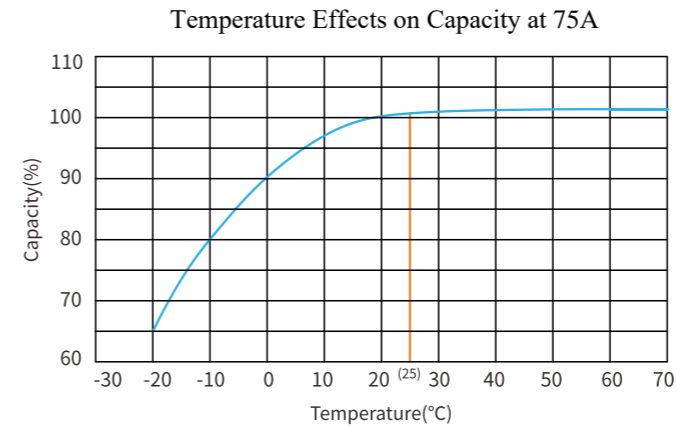
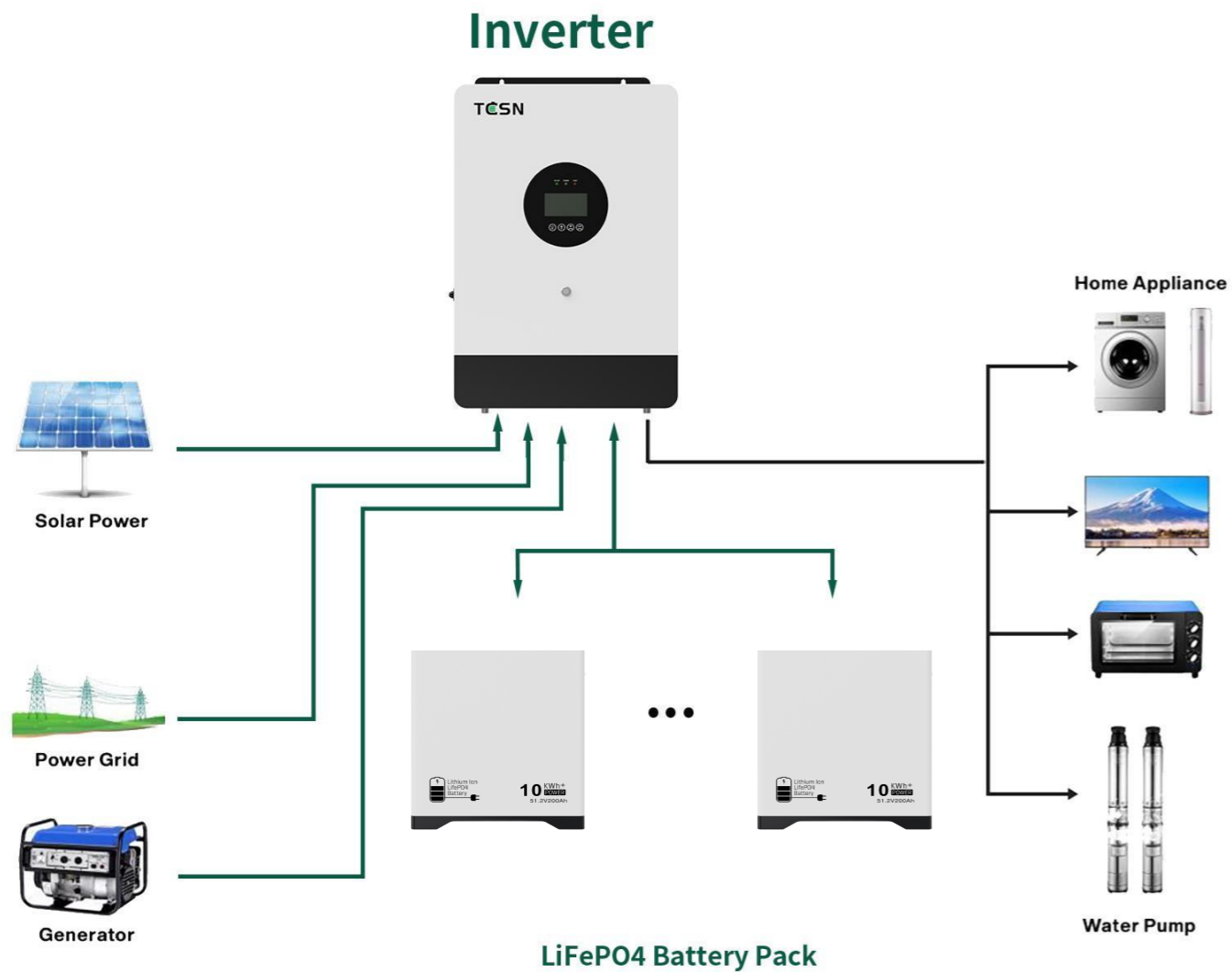

Cautions

1. Do NOT short circuit, crush or disassemble.
2. Do NOT heat or incinerate.
3. Do NOT immerse in any liquid.
4. Store at 50% capacity. Recharge every 3 months. The storage area should be clean, cool, dry and ventilated.
5. Disconnect charging source prior to connecting or disconnecting battery terminals.
6. Do not dispose of batteries in a fire as they can explode.
7. Do not open, alter, or mutilate batteries. Released electrolyte is harmful to skin and eyes. It may be toxic.
8. Do not mix different types and brands of lithium-ion batteries.
9. Do not dispose in trash, follow local regulations and manufacturer's instruction.
10. See installation instructions before connecting to the supply.
11. The battery cabinet receives power from more than one source. Disconnection of all DC sources is required to De-energize this unit before installing or servicing. Wait 5 minutes before opening the unit.
12. Do not install on or over combustible surfaces.
13. Refer to manual before servicing.
14. Do not touch bare terminals.

Characteristics Curve

